

robot coupe®



VEGETABLE PREPARATION MACHINES

CL 55 • CL 60 • CL 60 V.V.



RESTAURANTS - INSTITUTIONS - DELICATESSENS - CATERERS



CL 60 Automatic



* Except for feed-head base made in aluminium



- The Automatic feed-head combines an **outstanding cut quality** with **high output** (perfect balance between the shape of the hopper, the rotary speed and the surface of cutting disc).
- This head is ideal for **grated carrots** and **sliced or diced potatoes** for example. It has been conceived for all types of cut with the **exception of slicing of long products, processing fragile products or products that are too large for the feed hopper.**
- **Stainless steel feeding tray** designed to facilitate continuous supply into the machine.
- Recommended from 300 to 3000 covers and more.

- All parts in contact with food made from **stainless steel.**
- Heavy duty construction for **intensive use.**
- **Tilting of the heads** in the line of the motor base to guarantee space saving design and greater user comfort.
- Two speeds **375 rpm or 750 rpm** to guarantee perfect results and fast processing.
- Thanks to a simple design, all parts in food contact (for both models) **can be easily dismantled** without tools for **perfect hygiene.**
- Its **compact size**, the **wheels** and **handle** make the machine very easy to move.
- **Magnetic safety system** prevents any access to moving parts whatever head is in use.

CL 60 Pusher feed-head



- **New pusher feed head** (area : 227 cm²) designed for large vegetables processing with a **feed tube** (Ø 58 mm) **included** for long or fragile vegetables processing.
- The lever mounted on the feed-head has been designed for **ease of operation** and **minimum effort** on the part of the operator.
- **Automatic restart of the machine** with the pusher for better user comfort and a bigger output.
- The full size opening of the pusher feed-head minimizes the pre-cutting actions of vegetables for **time saving** and **better output.**
- Recommended from 300 to 400 covers and more.

VEGETABLE PREPARATION MACHINES

FLOOR MODELS



The Products "Plus"

Processing capacity :

- Large hopper feed head (area : 227 cm²) for large vegetables processing and an automatic feed head for continuous feeding.
- Powerful motor which guarantees large outputs (up to 900 kg/h).

Wide range of cut :

- Complete selection of 46 discs for slicing, grating, julienne, dicing and making French Fries.
- 4 different type of feed heads to guarantee a wide variety of tasks.

Simple and robust design :

- Mainly stainless steel for easy cleaning and a longer life.
- Parts in food contact are easy to dismantle and clean.



Number of covers :
up to 3000.



Target : For Hospitals & Institutions, Hotels, C P U's and Food Manufacture's.



In brief :

- **High performance, robust, easy to clean and maintain**, simple to use and versatile. Quite simply incomparable.

Operating time

up to 700 kg/h *

Processing time

up to 15 kg/mn *

Number of covers

100 to 1000 + *

CL 55

CL 60 • CL 60 V.V. (Variable Speed)

up to 900 kg/h *

up to 30 kg/mn *

300 to 3000 + *

* Depending on type of cut and head selected.

OPTIONAL ATTACHMENTS



4 Straight holes feed-head for CL55-CL60

- Designed for the preparation of long vegetables in large outputs.
- Diameters of the tubes : 2 tubes of 50 mm and 2 tubes of 70 mm



CL55 feeding tray

- Available in order to facilitate the loading of the vegetables in the pusher feed-head.



Half moon feed head CL55

- Area : 121 cm².
- Automatic restart of the machine with the pusher.



Straight hole feed-head CL60

- Designed for the preparation of **long vegetables** like carrots, cucumbers, leeks etc..., or **fragile fruit and vegetables** such as mushrooms, etc...



Straight and inclined hole feed-head CL55 - CL60

- Designed for the preparation of long vegetables and biaised cut.
- This head is equipped with an hole and pusher Ø 75 mm, one insert and pusher Ø 50 mm.



CL 60 stainless steel trolley

- Two stainless steel trolleys with locking wheels designed for 2 x 1 or 1 x 1 standard size containers..



CL 60 V.V. Variable Speed

- The CL60 V.V. variable speed allows a more accurate cut quality thanks to a speed range between **100 to 1000 rpm**. Consequently, a very precise **speed** can be selected according to the **type of cut** and **texture** of the **fruit or vegetable** to be processed.
- This guarantees an **optimum cut quality**, particularly when processing fragile products such as tomatoes or mushrooms and will **satisfy** even the **most demanding professionals**.
- As a standard, the CL60 V.V. variable speed is equipped with a stainless steel **automatic feed head**. Optional hoppers available are pusher feed-head or hole feed-heads.

CL 55 Automatic



- The CL55 model can be fitted with an **automatic feed-head** for **volume processing and cut quality**.
- The design of the **automatic feed-head** has been reviewed in order to give to the end-user a **larger introduction capacity and therefore bigger outputs**.
- The Automatic feed-head is ideal for **slicing delicate vegetables** such as mushrooms, tomatoes, **grating carrots**, **dicing potatoes** and cutting **French fries** to mention but a few of its use.
- **All stainless steel head** for easy cleaning and hygiene.

- **2 speeds for all models except for 380/60/3, 220/60/3 and single phase models.**
- Recommended from **100 to 1000 covers**.
- Operating time : up to **700 kg/h.**
- The optional **Stainless Steel mobile stand** gives the perfect operating height and accepts standard size gastronorm containers allowing you to prepare large quantity's with the minimum of fuss.
- **New blade contour** now gives an even **smoother, more durable cut.**
- Available with three phase or single phase powered motor.

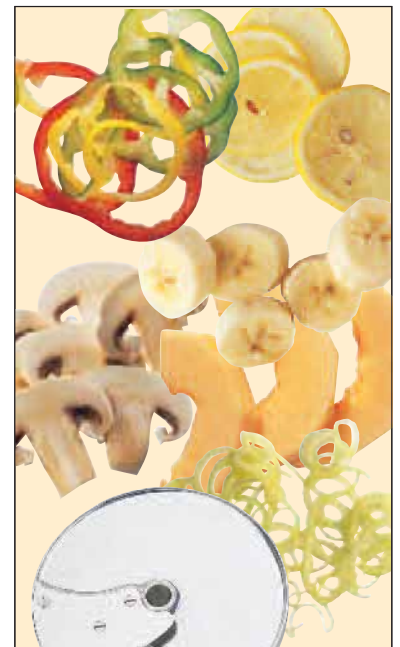

CL 55 Pusher feed-head











- **Robust construction** for commercial use.
- This model is equipped with a **pusher feed-head** (area : 227 cm²) including a feed tube (Ø 58 mm) and a stainless steel movable stand.
- The **full size opening head** has been specially designed for bulky vegetables such as cabbage or lettuce.
- The tube is used for **continuous feeding** of long or fragile fruit or vegetables.
- The shape of the pusher has been conceived for a better **use comfort** and for **fast processing**.







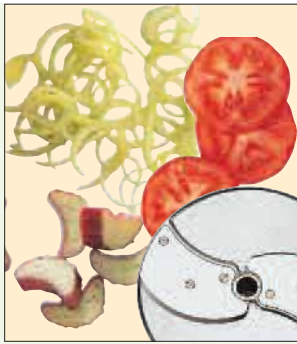

COMPLETE SELECTION OF DISCS

SLICER









-  0.6 mm Ref.28166
-  0.8 mm Ref.28069
-  1 mm Ref.28062
-  2 mm Ref.28063
-  3 mm Ref.28064
-  4 mm Ref.28004
-  5 mm Ref.28065
-  Cooked potatoes
4 mm Ref.27244
-  Cooked potatoes
6 mm Ref.27245







-  8 mm Ref.28066
-  10 mm Ref.28067
-  14 mm Ref.28068
-  20 mm Ref.28132
-  25 mm Ref.28133

JULIENNE / STRIPS





-  1x8 mm Ref.28172
-  1x30 mm Ref.28153
Half ring onions
-  2x2 mm Ref.28051
-  2x4 mm Ref.27072
-  2x6 mm Ref.27066
-  2x8 mm Ref.27067





-  2 x 10 mm
Ref.28173
-  3 x 3 mm
Ref.28101
-  4 x 4 mm
Ref.28052
-  6 x 6 mm
Ref.28053
-  8 x 8 mm
Ref.28054

RIPPLE CUT SLICER / FRENCH FRIES





-  2 mm
Ref.27068
-  3 mm
Ref.27069
-  5 mm
Ref.27070



-  8 x 8 mm
Ref.28134
-  10 x 10 mm
Ref.28135
-  10 x 16 mm
Ref.28158

GRATER



-  1.5 mm Ref.28056
-  2 mm Ref.28057
-  3 mm Ref.28058
-  4 mm Ref.28073
-  5 mm Ref.28059
-  7 mm Ref.28016
-  9 mm Ref.28060

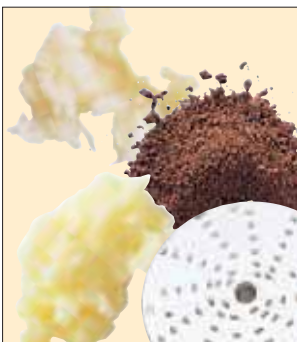

PARMESAN GRATER



Ref.28061

RÖSTIS POTATOES



Ref.27164





HORSERADISH PASTE



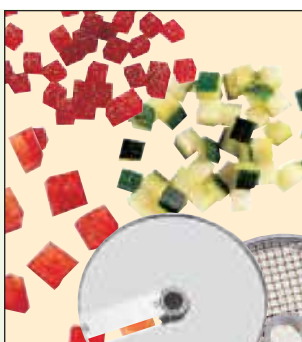



1mm Ref.28055

DICING EQUIPMENT

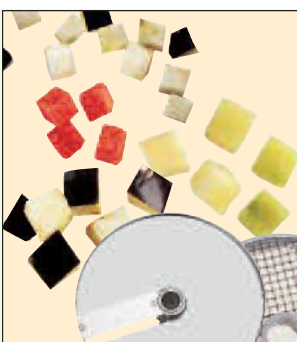

-  5 x 5 x 5 mm
Ref.28110
-  8 x 8 x 8 mm
Ref.28111
-  10 x 10 x 10 mm
Ref.28112
-  14 x 14 x 14 mm
Ref.28113



-  20 x 20 x 20 mm
Ref.28114
-  25 x 25 x 25 mm
Ref.28115
-  50 x 70 x 25 mm
(salad)
Ref.28180

CE mark

CL55 Dimensions (in mm)

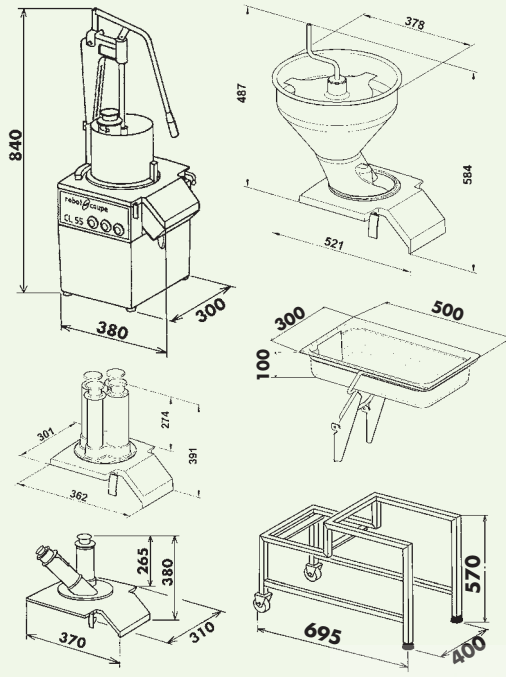

CL60 - CL60 V.V. Dimensions (in mm)

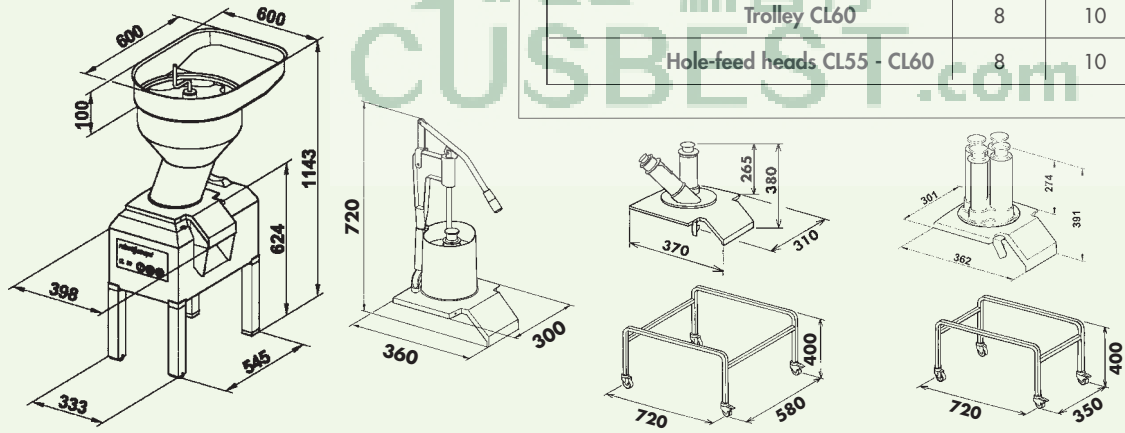

Electrical data

	Speed (rpm)	Power (Watts)	Intensity (Amp.)	Voltage
CL55	375 and 750	1 100	1.4	400 V 50 Hz / 3
CL60	375 and 750	1 500	3.4	400 V 50 Hz / 3
CL60 V.V.	375 to 750	1 500	12	230 V 50-60 Hz / 1

Weight (kg)

	net	gross
CL55 (Motor base)	18	19
CL60 (Motor base)	43	57
CL60 V.V. (Motor base)	43	57
Automatic feed head CL55	6.2	7.2
Automatic feed head CL60	13	16
Pusher-feed head CL55	9	14
Pusher-feed head CL60	7	12
Stand (CL55)	8	10
Feeding tray (CL55)	3.5	6
Trolley CL60	8	10
Hole-feed heads CL55 - CL60	8	10

* Other voltages available.

STANDARDS: Machines in compliance with:

- Is in conformity with the following directives and with standards and relations regarding safety and hygiene: 98/37/CEE, 73/23/CEE, 89/336/CEE, 89/109/CEE, 90/128/CEE.
- Is in conformity with the following European Harmonised Standards: EN 292 - 1 and - 2, EN 60204 - 1 (1998), EN 1678.



MADE IN FRANCE BY ROBOT-COUCPE S.N.C.

Head Office, French, Export and Marketing Department:

Tel. : + 33 1 43 98 88 33 - Fax: + 33 1 43 74 36 26

48, rue des Vignerons - 94305 Vincennes Cedex - France

http://www.robot-coupe.com - email : international@robot-coupe.com

Robot-Coupe Australia: Tél. : 02-9417 6233 - Fax: 02-9417 6787

P.O. Box 146 - Northbridge NSW 1560 - http://www.robotcoupe.com.au

Robot-Coupe U.K. LTD: Tel. : 020 8232 1800 - Fax: 020 8568 4966

2, Fleming Way, Isleworth, Middlesex TW7 6EU - http://www.robot-coupe.co.uk

Robot-Coupe U.S.A.: Ph. : 1-800-824-1646 - Fax : 601-898-9134

P.O. Box 16625 - Jackson, Mississippi 39236-6625 - http://www.robotcoupeusa.com

DISTRIBUTOR

We reserve the right to alter at any time without notice the technical specifications of this appliance. None of the information contained in this document is of a contractual nature. Modifications may be made at any time.
© All rights reserved for all countries by : ROBOT-COUCPE S.N.C.